

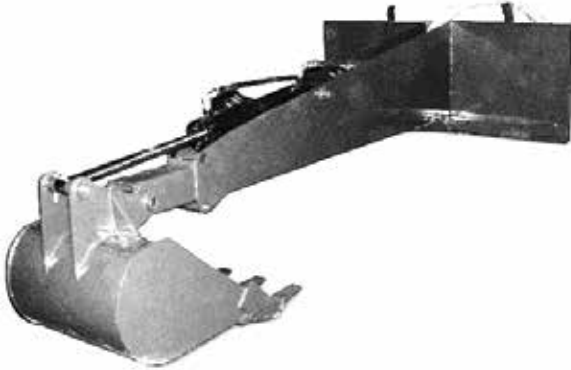

Extreme Stiff Arm Backhoe



Owner's/Operator's Manual



WARNING

For safe operation, read these rules and instructions carefully to avoid accidents that could result in Death or Serious Injury.

TO THE OWNER/OPERATOR OF THIS IMPLEMENT

Please read this manual "before" unpacking or using this implement for the first time. This manual provides you with the necessary instructions to safely install and use your purchase. Do not let other people use this attachment without first being instructed how to safely use it.



MADE IN USA

Carolina Attachments LLC.

107 E Holly Hill Rd.
Thomasville, NC 27360

Toll Free 888-676-7309 • Local 336-474-7309

www.carolinaattachments.com

Save this manual for future reference!

Thank You

At Carolina Attachments we strive to provide you with quality skid steer & tractor loader attachments and accessories. All of our products are crafted here in the United States. We are a family owned and operated business and we aim to provide you with the best possible customer service available. Here at Carolina Attachments we have a variety of attachments to fit any job you may have whether it be industrial, farm related, or for your personal home. All of our items can be customized to fit your specific needs upon request. Please do not hesitate to contact us with any questions you may have!

Information

Record product information here for future reference.

Model _____
S/N or MFG. Date _____
Bucket Size: 8" _____ 12" _____ 16" _____
20" _____ 24" _____
Dealer Name _____
Dealer Phone ____ - ____ - _____
Date of Purchase ____/____/_____

Table of Contents

Orientation	3
Importance of Safety	3
Operator Safety Training Tips	4
Unpacking Your Shipment	5
Using Your Implement	5
Connecting Backhoe to Skid Steer..	5
Backhoe Controls	6
Using Auger the First Time	6
Getting Familiar with the Attachment	6
Before Digging	7
Digging Tips	7
Maintaining your Attachment	8
Before Every Use	8
Every Week	8
After Every Season	8
Specifications	8
Parts.....	9
Backhoe Parts.....	10
Decals.....	11
Limited Warranty.....	12

Orientation

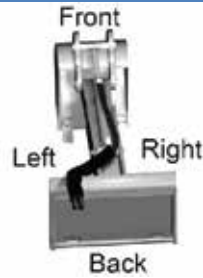

Serial Number Plate is Located on Top of Mounting Plate

Importance of Safety

Accidents can be very costly to human life and property. As the operator is the #1 safety device on all types of vehicles or equipment, it is important that the operator read, learn and know all safety recommendations for this product. The user is responsible to his family, friends and co-workers to operate in a safe manner. Ensure that everyone who operates or assists in the operation or maintenance of this product read and understand all the elements required to safely operate this piece of equipment.

This attachment has pinch points that include additional dangers.

Throughout this manual you will find safety notes which are very important to read and understand before operating this piece of equipment. These classifications alert you to situations that could be harmful to you or bystanders. When you see these alerts in the manual, carefully read and follow all instructions and also protect other workers from the same danger.

 **DANGER** Will result in Death or Serious Injury.

 **WARNING** Could result in Death or Serious Injury.

 **CAUTION** Could result in Minor or Serious Injury.

 **NOTICE** Not related to Personal Injury.

Operator Safety Training Tips

It is the responsibility of the operator using this attachment to be acquainted with the safe operation. In addition to reading this manual, it is important that the operator read the skid steer's operation manual and follow its manufacturer's recommendations!

 Know the area before digging. Always contact your local "Diggers Hotline" or "One-Call" to have underground utilities marked.

 Before raising, lowering or swinging the machine & backhoe, make sure area is clear of bystanders or objects.

 Machinery parts sometimes have sharp edges. Wear work gloves when moving parts.

 Never use drugs or alcoholic drinks when operating or servicing this piece of equipment.

 Always wear the proper personal protection equipment when servicing or operating this piece of equipment. Never service or operate this attachment with bare feet, sandals, or other light footwear.

 Always use eye protection during operation.

 Speed Kills! Operate this implement at a safe working speed. When transporting the implement, keep a safe speed to avoid losing control of the attachment or prime mover.

 Keep proper clearance between the implement and objects (tree stumps, large rocks, buildings, etc.). Contacting these objects with the implement or prime mover could cause a loss of control or damage to the implement.

 Before each operation of this implement, check all hardware (bolts, nuts, pins, cotter pins, etc.) for their proper location and tightness.

 Stop the engine on the skid steer and set the brake to avoid the implement rolling forward or backwards while you are exiting the prime mover.

 Store this implement in an area not frequented by children.

 Allow no riders on this attachment. Keep all bystanders clear of attachment during operation.

 Always replace worn, torn or missing safety decals before operating.

 Never operate the backhoe when bystanders are within 20 feet (6 m) of the work area.

Skid Steer Requirements

Your backhoe attachment is compatible with attachment couplers from all major skid steer manufacturers. This backhoe should only be used on skid steers with a compatible attachment coupler.

A skid steer equipped with tracks will provide superior traction in this application.

CAUTION *Make sure your skid steer is in good working condition. Follow the operating instructions found in the manual that accompanied your skid steer. Failure to do so could result in Minor or Serious Injury.*

Unpacking Your Shipment

Your attachment arrives from the factory banded to a wooden pallet, and requires no final assembly.

CAUTION *Careless removal of the shipping bands that secure the implement to the pallet could result in Minor or Serious Injury. Clear the area of all bystanders and stand to the side when cutting the bands with a pair of sheet metal shears.*

Using Your Implement

Connecting Attachment to Skid Steer

DANGER *Never enter the area underneath the coupler or any part of the attachment when it is in the raised position to avoid an*

accident that will result in Death or Serious Injury.

Verify that the hydraulic hoses are clear from the front of the attaching plate on the attachment and that the mounting plate is free from dirt and debris. When clear, move the skid steer to proximity of attachment plate. Tilt skid steer coupler forward to align coupling point with the upper part on the attachment plate and raise the coupler slightly.



Connecting Coupler to Attachment

When the top edge of the coupler is seated in the top part of the coupler plate, roll the skid steer tilt function back until the attaching plate is flat against the skid steer coupler. Lock down the coupler levers.

PLEASE NOTE:
Attachment and Machine-side Couplings must be **FREE OF DEBRIS BEFORE INSTALLING.**
Failure to comply will void warranty.

NOTICE *Wipe off any dirt or dust from the male or female hydraulic flat-face couplers with a clean rag before attaching hoses, to keep contaminants from entering the hydraulic system.*

Connect the backhoe hydraulic hoses to the auxiliary circuit connectors on the skid steer.

Check the surrounding area for bystanders and clear them before starting the skid steer or attachment.

Before operating the attachment, always visually inspect and verify that the coupler lock pins are fully engaged through the latch slots on the attachment plate.

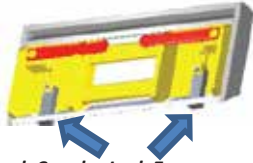

Check Coupler Lock Engagement

Backhoe Controls

The Stiff Arm Backhoe uses the loader arm lift and the attachment tilt controls of the skid steer loader. Consult your skid steer operator's manual for instructions on how to operate the lift and tilt controls.

Swinging the back hoe to one side or the other relies on the skid steer motion of the prime mover. To move the backhoe arm to the right, counter-rotate the skid steer to the right using the skid steer's drive controls. To move the backhoe arm to the left, counter-rotate the skid steer to the left using the skid steer's drive controls.

The auxiliary hydraulic control of the skid steer loader will provide hydraulic fluid to make the bucket curl in or curl out.

With practice, the operation of all the functions listed above will provide an easy means to dig a trench or a hole.

Using Auger the First Time

NOTICE *If this is your initial startup with this attachment on this machine, check the skid steer's*

hydraulic oil level and add oil, if necessary, before and after doing steps 1- 3 below.

After starting skid steer, lift the attachment 36" (915mm) off the ground surface:

1. With the skid steer engine RPMs just above idle, engage the auxiliary hydraulic flow to the bucket circuit. Rotate the bucket back and forth several times to eliminate any air in the circuit.
2. Return backhoe to the level position and rest the attachment bucket on the ground.
3. Shut off the skid steer's engine and exit the operator's compartment.
4. Check the skid steers hydraulic oil level, and add oil if necessary.
5. Inspect the backhoe's hydraulic plumbing for any noticeable leaks. Correct these leaks before continuing.

Getting Familiar with the Attachment

⚠ DANGER *Never operate the backhoe when bystanders are within 20' (6 m) of your work area. Flying debris or trench cave-in could result in Death or Serious Injury.*

⚠ CAUTION *Be cautious when operating on un-level ground surfaces. A machine roll over could result in Minor or Serious Injury. Always wear your seat belt when operating this attachment.*

Before starting the skid steer engine with this backhoe attached, make sure you are knowledgeable and comfortable with the operation of the skid steer controls as outlined in the skid steer's Operator's Manual.

When operating the backhoe, set the skid steer throttle at a speed that provides the necessary power to lift the backhoe and counter-rotate the drive tires at the same time. Note: It is not necessary to operate this attachment with the skid steer's throttle at the full open position.

Learn what the backhoe bucket looks like in a level digging position when you are seated in the skid steer. Knowing what a level bucket looks like will help you maintain a level bottom during a trenching operation.

Before Digging

⚠ WARNING *Before digging into any surface, always contact the "Diggers Hotline" to identify underground utilities to avoid an accident that could result in Death or Serious Injury to the operator or fellow workers.*

Section your intended work area off with cones and yellow barrier tape that includes not only the trenching area, but also the complete swing radius of the attachment. Stop operating if anyone steps inside the designated safety zone.

Digging Tips

⚠ WARNING *Exposure to crystalline silica dust along with other hazardous dusts may cause serious or fatal respiratory disease. Wear a dust mask whenever working in dusty environments.*

⚠ CAUTION *Never operate this attachment when bystanders are in proximity of the work area that could result in Minor or Serious Injury from flying debris or trench wall cave-in.*

1. Operate at a safe -paced speed that will allow you to watch the area being excavated and the area around the skid steer.
2. Make sure you are operating the skid steer's engine at an rpm that will produce the volume of oil flow required for this attachment and skid steer's drive circuit. In most instances, your engine's RPMs will be set at about half speed.
3. Do not use this attachment to "push" down trees.
4. Listen to your skid steer. If the bucket circuit stalls, you may be taking too big of a bite. Lift the boom slightly and attempt to curl the bucket again, taking a smaller bite.
5. Use a combination of loader arm and attachment plate tilt and bucket curl to fill the bucket. With practice, using all three functions simultaneously will result in a level trench bottom.



Trenching

6. You may also use the skid steer (reverse) drive system to help fill the bucket once the bucket has been lowered into position.
7. Lift the attachment above the ground surface before swinging backhoe with the skid steer drive system.
8. To swing the backhoe to the right, use the skid steer drive system to smoothly counter-rotate in the desired direction.
9. Avoid excessive side loading on this attachment.

Maintaining your Attachment



CAUTION Not

maintaining your implement correctly could result in Minor or Serious Injury. Keep your implement in top operating condition.

Before Every Use

Check that all fasteners (nuts, bolts, pins, keepers) are in their right place and are tight.

Inspect and replace any worn, torn or missing safety decals.

Pump No. 2 lithium or molybdenum disulfide grease into all required areas until you see old grease is being flushed out.

Investigate the location of any oil leaks and repair.

After every use, clean off any dirt residue with a garden hose and repeat grease application.

Every Week

Inspect the bucket teeth and replace any worn or broken teeth.

After Every Season

Inspect the implement for any loose or worn parts that may need to be replaced prior to the next season.

Clean, sand & repaint any area that looks worn or scratched to prevent further rusting. Use an equipment-paint found at your local hardware store or building center.

Lubricate all pivot joints. If located in an area near an ocean or other corrosive conditions, apply a thin layer of grease to any exposed cylinder rod surfaces. Wipe grease from cylinder rods with a clean rag when taking the attachment out of storage.

Store your implement in a shed or cover with a water-proof tarp to protect it from the weather. Store in an area not frequented by children.

Specifications

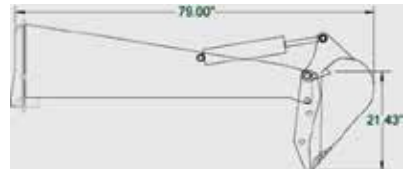

Spec.	Measurement
Attachment Length	79" (2006mm)
Dig Depth	7' (2.13m)
Attachment Weight less Bucket	500 lbs. (227 kg)
Bucket Weights:	
8"	65 lbs. (30 kg)
12"	100 lbs. (45 kg)
16"	125 lbs. (57 kg)
20"	150 lbs. (68 kg)
24"	175 lbs (79 kg)

Parts

When requiring any parts for your implement, please collect the following information:

- Implement Model Number
- Implement Serial Number
- Parts Manual Date (lower right corner)
- Parts Manual Page
- Part Description
- Quantity Required
- Ship-to Name & Address
- Payment Method

...then call your local dealer for factory fresh parts specifically designed for your attachment.

Backhoe Parts

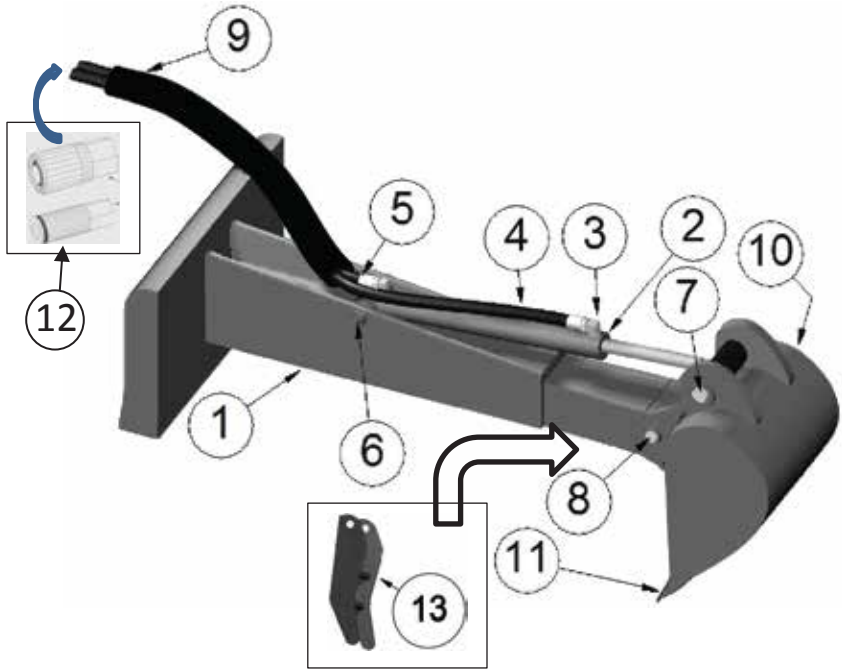

Ref.	Description	Qty.
1	Main Frame	1
2	Tool Cylinder	1
3	Fitting, 90°	2
4	Hose (Rod end of Cylinder to Loader)	1
5	Hose (Base end of cylinder to Loader)	1
6	Pin, (Cylinder base end to frame)	1
7	Pin, (Cylinder rod end to bucket)	1
8	Pin, (Bucket pivot)	1
9	Sleeve, Protective (slides over hoses)	1
10	Bucket 8"	1
	Bucket 12"	1
	Bucket 16"	1
	Bucket 20"	1
	Bucket 24"	6
11	Tooth, Bucket	AR
12	Quick Disconnect Coupling Set	1
13	Thumb (Optional) Kit	1

Decals

1*

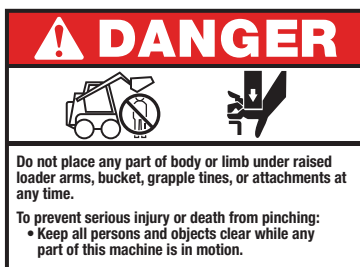

2*



3



Ref.	Description	Qty.
1*	Decal, (Danger Pinch Points)	1
2*	Decal, (Warning, High Pressure Fluid Hazard)	1
3	Identification Plate (Metal Plate)	1

*



Replace any worn, torn or missing safety decals before operating!



**107 E Holly Hill Rd.
Thomasville, NC 27360**

Owner's Manual

Stiff Arm Backhoe

Website

www.carolinaattachments.com

For More Information, Contact

Wesley@Carolinaattachments.com

Toll Free 888-676-7309

Local 336-474-7309

Limited Warranty

Carolina Attachments, LLC, a manufacturer of quality skid steer attachments offers a 1 year limited warranty on all of our attachments. Excluding economy series attachments.

Carolina Attachments, LLC liability for any defect with respect to accepted goods shall be limited to repairing the goods at Carolina Attachments, LLC location or replacing them as Carolina Attachments, LLC shall elect. The above shall be in accordance with Carolina Attachments, LLC adjustment policies. Carolina Attachments, LLC obligation shall terminate twelve (12) months after the delivery of the attachment to original purchaser. This warranty shall not apply to any machine or attachment which shall have been repaired or altered outside Carolina Attachments, LLC. It will be Carolina Attachments, LLC judgment, to affect its stability or reliability, nor which has been misuse, negligence or accident beyond the manufacturer recommended machine rated capacity. If you have any questions in regards to this limited warranty please contact Carolina Attachments, LLC.

Warranty Claim

To submit a warranty claim, authorization from Carolina Attachments, LLC must be obtained. This warranty does not include freight or delivery charges incurred when returning attachment for servicing. Pickup/delivery charges are the customer's responsibility.

Exclusions of Warranty

Except as otherwise expressly stated herein, Carolina Attachments, LLC makes no representation or warranty of any kind, expressed or implied, AND MAKES NO WARRANTY OF MERCHANTABILITY IN RESPECT TO IF ATTACHMENTS ARE FIT FOR ANY PARTICULAR PURPOSE. Carolina Attachments, LLC is not liable for any inconvenience, rental or replacement equipment, loss of profits or other commercial loss. Buyer assumes all liability for all personal injury and property resulted from the handling, possession or use of the attachment by the buyer.