



## **Extreme Swing Boom Backhoe**



# **Owner's/Operator's Manual**



### **WARNING**

For safe operation, read these rules and instructions carefully to avoid accidents that could result in Death or Serious Injury.

#### **TO THE OWNER/OPERATOR OF THIS IMPLEMENT**

Please read this manual "before" unpacking or using this implement for the first time. This manual provides you with the necessary instructions to safely install and use your purchase. Do not let other people use this attachment without first being instructed how to safely use it.



**Carolina Attachments LLC.**

107 E Holly Hill Rd.

Thomasville, NC 27360

Toll Free 888-676-7309 • Local 336-474-7309

[www.carolinaattachments.com](http://www.carolinaattachments.com)

***Save this manual for future reference!***

# Thank You

---

At Carolina Attachments we strive to provide you with quality skid steer & tractor loader attachments and accessories. All of our products are crafted here in the United States. We are a family owned and operated business and we aim to provide you with the best possible customer service available. Here at Carolina Attachments we have a variety of attachments to fit any job you may have whether it be industrial, farm related, or for your personal home. All of our items can be customized to fit your specific needs upon request. Please do not hesitate to contact us with any questions you may have!

# Information

---

Record product information here for future reference.

Model _____
S/N or MFG. Date _____
Bucket Size: 8" _____ 12" _____ 16" _____ 20" _____ 24" _____
Dealer Name _____
Dealer Phone ____-____-____
Date of Purchase __/__/____

# Table of Contents

Thank You .....	2
Information.....	2
Orientation .....	3
Importance of Safety .....	3
Operator Safety Training Tips .....	4
Skid Steer Requirements .....	5
Unpacking Your Shipment .....	6
Using Your Implement .....	6
Connecting Backhoe to Skid Steer..	6
Backhoe Controls .....	6
Using Backhoe the First Time .....	7
Getting Familiar with the Attachment .....	7
Before Digging.....	8
Digging Tips .....	8
Maintaining your Attachment .....	9
Before Every Use .....	9
Every Week .....	9
After Every Season .....	9
Converting to Offset Backhoe Position .....	9
Hardware Torque .....	11
Specifications.....	11
Parts.....	12
Decals.....	12
Backhoe Parts.....	13
Hydraulic Parts .....	14
Troubleshooting .....	15
Limited Warranty.....	16

## Orientation

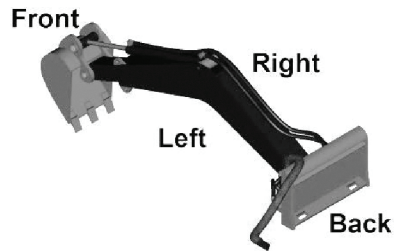

*Serial Number Plates Located on Top of Mounting Plate*

## Importance of Safety

Accidents can be very costly to human life and property. As the operator is the #1 safety device on all types of vehicles or equipment, it is important that the operator read, learn and know all safety recommendations for this product. The user is responsible to his family, friends and co-workers to operate in a safe manner. Ensure that everyone who operates or assists in the operation or maintenance of this product read and understand all the elements required to safely operate this piece of equipment.

This attachment has pinch points that include additional dangers.

Throughout this manual you will find safety notes which are very important to read and understand before operating this piece of equipment. These classifications alert you to situations that could be harmful to you or bystanders. When you see these alerts in the manual, carefully read and follow all instructions and also protect other workers from the same danger.

 **DANGER** Will result in Death or Serious Injury.

 **WARNING** Could result in Death or Serious Injury.

 **CAUTION** Could result in Minor or Serious Injury.

 **NOTICE** Not related to Personal Injury.

## Operator Safety Training Tips

It is the responsibility of the operator using this attachment to be acquainted with the safe operation. In addition to reading this manual, it is important that the operator read the skid steer's operation manual and follow its manufacturer's recommendations!

 Know the area before digging. Always contact your local "Diggers Hotline" or "One-Call" to have underground utilities marked.

 Before raising, lowering or swinging the machine & backhoe, make sure area is clear of bystanders or objects.

 Machinery parts sometimes have sharp edges. Wear work gloves when moving parts.

 Never use drugs or alcoholic drinks when operating or servicing this piece of equipment.

 Always wear the proper personal protection equipment when servicing or operating this piece of equipment. Never service or operate this attachment with bare feet, sandals, or other light footwear.

 Always use eye protection during operation.

 Speed Kills! Operate this implement at a safe working speed. When transporting the implement, keep a safe speed to avoid losing control of the attachment or prime mover.

 Keep proper clearance between the implement and objects (tree stumps, large rocks, buildings, etc.). Contacting these objects with the implement or prime mover could cause a loss of control or damage to the implement.

 Before each operation of this implement, check all hardware (bolts, nuts, pins, cotter pins, etc.) for their proper location and tightness.

 Stop the engine on the skid steer and set the brake to avoid the implement rolling forward or backwards while you are exiting the prime mover.

 Store this implement in an area not frequented by children.

 Allow no riders on this attachment. Keep all bystanders clear of attachment during operation.

 Always replace worn, torn or missing safety decals before operating.

 Never operate the backhoe when bystanders are within 20 feet (6 m) of the work area.

# Skid Steer Requirements

Your backhoe attachment is compatible with attachment couplers from all major skid steer manufacturers. This backhoe should only be used on skid steers with a compatible attachment coupler.

A skid steer equipped with tracks will provide superior traction in this application.

You will install the electrical toggle switch that accompanies this attachment or your skid steer must be equipped with an auxiliary electrical option with an electrical connector mounted on the machine's loader lift arm from the skid steer manufacturer. In order to complete the connection, the mating connector on the loader arm needs to match the connector from the attachment.

**⚠ WARNING** *A 12 V power source coming directly from the battery or from some other circuit that is energized all the time could result in Death or Serious Injury if the attachment control switch is accidentally bumped when the operator is entering or exiting the skid steer with the engine running.*

**⚠ WARNING** *California Proposition 65 Warning! Battery posts, terminals, and related accessories contain lead and lead components, chemicals known to the State of California to cause cancer and reproductive harm. Wash hands after handling.*

**⚠ CAUTION** *Always refer to the polarity symbols printed on the top of the battery. Refer to the markings on the battery to determine*

*the location of the negative (-) cable. If the battery cables are to be removed from the battery, always remove the negative cable first and reinstall the negative cable last.*

**⚠ WARNING** *DO NOT smoke around a battery, or use anything that produces an open flame or spark to avoid an explosion that could result in Death or Serious Injury.*

The 12V power source for this attachment should be connected into the skid steer's Operator Presence System that cuts the electrical power to the attachment shift valves if the operator safety restraint bar is raised or the seat switch is disengaged when the operator raises from the seat. Consult with your local skid steer dealer for assistance.

When using the provided switch, route the electrical harness up to the pivot point of the loader arm and tie it with plastic cable ties to the inside of the loader arm to prevent snagging the harness with branches. After installing harness, check that the harness is free from any tension when raising and lowering the loader arm through its complete cycle.



*Route harness to back of loader pivot and on the inside of loader arm*

**⚠ CAUTION** *Make sure your skid steer is in good working condition. Follow the operating instructions found in the manual that accompanied your skid steer. Failure*

*to do so could result in Minor or Serious Injury.*

## Unpacking Your Shipment

Your attachment arrives from the factory banded to a wooden pallet, and requires no final assembly.

**CAUTION** Careless removal of the shipping bands that secure the implement to the pallet could result in Minor or Serious Injury. Clear the area of all bystanders and stand to the side when cutting the bands with a pair of sheet metal shears.

## Using Your Implement

### Connecting Backhoe to Skid Steer

**DANGER** Never enter the area underneath the coupler or any part of the attachment when it is in the raised position to avoid an accident that will result in Death or Serious Injury.

Verify that the hydraulic hoses are clear from the front of the attaching plate on the attachment and that the mounting plate is free from dirt and debris. When clear, move the skid steer to proximity of attachment plate. Tilt skid steer coupler forward to align coupling point with the upper part on the attachment plate and raise the coupler slightly.

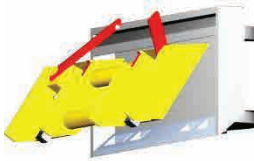

**Connecting Coupler to Attachment**

When the top edge of the coupler is seated in the top part of the coupler plate, roll the skid steer tilt function back until the attaching plate is flat against the skid steer coupler. Lock down the coupler levers.

**NOTICE** Wipe off any dirt or dust from the male or female hydraulic flat-face couplers with a clean rag before attaching hoses, to keep contaminants from entering the hydraulic system.

Connect the backhoe hydraulic hoses to the auxiliary circuit connectors on the skid steer.

Connect the electrical harness to the harness on the machine that connects the switch in the cab to the attachment.

Check the surrounding area for bystanders and clear them before starting the skid steer or attachment.

Before operating the attachment, always visually inspect and verify that the coupler lock pins are fully engaged through the latch slots on the attachment plate.

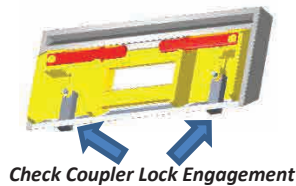

### Backhoe Controls

The Swing Boom Backhoe uses the loader arm lift and the attachment tilt controls of the skid steer loader. Consult your skid steer operator's manual for instructions on how to operate the lift and tilt controls.

Swinging the back hoe to one side or the other relies on the skid steer motion powered by the swing cylinder mounted on the attachment. To move the backhoe arm to the right, move the switch to the position for “swinging right.” To move the backhoe arm to the left, toggle the switch to the “left” direction.

The auxiliary hydraulic control of the skid steer loader will provide hydraulic fluid to make the bucket curl in or curl out.

With practice, the operation of all the functions listed above will provide an easy means to dig a trench or a hole.

## Using Backhoe the First Time

**NOTICE** *If this is your initial startup with this attachment on this machine, check the skid steer’s hydraulic oil level and add oil, if necessary, before and after doing steps 1- 4 below.*

After starting skid steer, lift the attachment 36” (915mm) off the ground surface:

1. With the skid steer engine RPMs just above idle, engage the auxiliary hydraulic flow to the bucket circuit. Rotate the bucket back and forth several times to eliminate any air in the circuit.
2. Operate the swing by slowly rotating the boom from stop-to-stop.
3. Return backhoe to the level position and rest the attachment bucket on the ground.
4. Shut off the skid steer’s engine and exit the operator’s compartment.

5. Check the skid steers hydraulic oil level, and add oil if necessary.
6. Inspect the backhoe’s hydraulic plumbing for any noticeable leaks. Correct these leaks before continuing.

## Getting Familiar with the Attachment

**WARNING** *Never operate the backhoe when bystanders are within 20’ (6 m) of your work area. Flying debris or trench cave-in could result in Death or Serious Injury.*

**WARNING** *Verify that fellow workers or bystanders remain at a distance from your total area of work to avoid an accident that could result in Death or Serious Injury, if struck by the backhoe boom or bucket during operation.*

**CAUTION** *Be cautious when operating on un-level ground surfaces. A machine roll over could result in Minor or Serious Injury. Always wear your seat belt when operating this attachment.*

Before starting the skid steer engine with this backhoe attached, make sure you are knowledgeable and comfortable with the operation of the skid steer controls as outlined in the skid steer’s Operator’s Manual.

When operating the backhoe, set the skid steer throttle at a speed that provides the necessary pressure to lift the backhoe with a full bucket of dirt or provide adequate power to optimize the backhoe’s bucket breakout force. It is not necessary to run the skid steer’s engine at full RPM when using this attachment.

Learn what the backhoe bucket looks like in a level digging position when you are seated in the skid steer. Knowing what a level bucket looks like will help you maintain a level bottom during a trenching operation.

## Before Digging

**⚠️ WARNING** *Before digging into any surface, always contact the “Diggers Hotline” to identify underground utilities to avoid an accident that could result in Death or Serious Injury to the operator or fellow workers.*

Take a moment to survey the excavation site. Plan your strategy to determine the best direction of the cut, where to place the spoil pile, as well as planning adequate access for workers who may need to access the trench or hole after you have completed the excavation.

## Digging Tips

**⚠️ WARNING** *Exposure to crystalline silica dust along with other hazardous dusts may cause serious or fatal respiratory disease. Wear a dust mask whenever working in dusty environments.*

**⚠️ CAUTION** *Never operate this attachment when bystanders are in proximity of the work area that could result in Minor or Serious Injury from flying debris or trench wall cave-in.*

1. Section off your intended work area with cones and yellow barrier tape that includes not only the trenching area, but also the complete swing radius of the attachment. Stop operating if

anyone steps inside the designated safety zone.

2. Operate at a safe -paced speed that will allow you to watch the area being excavated and the area around the skid steer.
3. Make sure you are operating the skid steer’s engine at an rpm that will produce the volume of oil flow required for this attachment. In most instances, your engine’s RPMs will be set at about half speed.
4. If the swing action seems too quick and/or erratic, turn the flow valve counter-clockwise ¼ turn, then test again (See Item 16 on page14 in this manual). Repeat this procedure until you feel comfortable with the swing speed.
5. Do not use this attachment to “push” down trees.
6. Listen to your skid steer. If the bucket circuit stalls, you may be taking too big of a bite. Lift the boom slightly and attempt to curl the bucket again, taking a smaller bite while filling the bucket.
7. Use a combination of loader arm and attachment plate tilt and bucket curl to fill the bucket. With practice, using all three functions simultaneously will result in a level trench bottom.



**Trenching**

8. **To secure the skid steer in position while excavating, set the machine’s parking brake while digging.**
9. After filling the bucket with material, lift the bucket above the



ground surface before swinging the backhoe.

10. Avoid excessive side loading on this attachment.
11. If you will be backfilling your trench with the backhoe, scoop and dump the material in the hole. Use the backhoe bucket as a tool to tamp the material in the hole.

## Maintaining your Attachment

**⚠ CAUTION** *Not maintaining your implement correctly could result in Minor or Serious Injury. Keep your implement in top operating condition.*

### Before Every Use

Check that all fasteners (nuts, bolts, pins, keepers) are in their right place and are tight.

Inspect and replace any worn, torn or missing safety decals.

Pump No. 2 lithium or molybdenum disulfide grease into all required areas until you see old grease is being flushed out.

Investigate the location of any oil leaks and repair.

After every use, clean off any dirt residue with a garden hose and repeat grease application.

### Every Week

Inspect the bucket teeth and replace any worn or broken teeth.

## After Every Season

Inspect the implement for any loose or worn parts, (including decals) that may need to be replaced prior to the next season.

Clean, sand & repaint any area that looks worn or scratched to prevent further rusting. Use an equipment-paint found at your local hardware store or building center.

Lubricate all pivot joints. If located in an area near an ocean or other corrosive conditions, apply a thin layer of grease to any exposed cylinder rod surfaces. Wipe grease from cylinder rods with a clean rag when taking the attachment out of storage.

Store your implement in a shed or cover with a water-proof tarp to protect it from the weather. Store in an area not frequented by children.

## Converting to Offset Backhoe Position

Your Swing Boom Backhoe can be offset on the mounting bracket to enable the attachment to excavate alongside a building, fence or other structure.



***Back in Offset Position, Excavating next to wall***

The conversion from the center-mount position to the offset position should

be completed in a workshop that has an overhead hoist or crane.

1. Attach the backhoe to a skid steer and secure it to the attachment coupler as previous explained in this manual.
2. Raise the skid steer coupler and attachment about 10" (250mm) off the floor and slide two 8" X 8" blocks or timbers under the backhoe mounting frame. Place the blocks in a position that will not hinder access to the backhoe swivel pin or swing cylinder mounting. Rest the backhoe attaching plate on the blocks, but leave the skid steer connected to the attachment
3. Attach the overhead hoist/crane to the backhoe boom using a sling or chain slung around the mid-section of the boom.





**Supporting Boom during Conversion**

**⚠ WARNING** *Always release the hydraulic pressure from the attachment circuit prior to disconnecting any part of the hydraulic circuit. A small stream of oil could penetrate your skin and result in Death or Serious Injury. Never use your hand or any other body part to locate a hydraulic leak.*

4. Loosen and disconnect the hoses from the swing cylinder.
5. Remove the hardware securing the swing cylinder base to attachment frame.

6. Check the tension on the hoist strap to verify that the weight of the boom is being supported by the hoist.
7. Remove the hardware securing swing pin to frame and remove the swing pin.
8. When the boom pivot pin has been removed, relocate the boom to the pivot location near the right side of the attachment mounting frame. Install the swing pivot pin and securement hardware.
9. Position the swing cylinder base to the alternate pivot mounting hole and install pin and associated hardware.
10. Connect and reposition the swing cylinder hoses and tighten.
11. Check your work. Make sure all hardware and hydraulic fittings have been tightened.
12. Lubricate the swing pivot and swing cylinder pivots joints.
13. Remove the boom weight from the hoist and remove strap or chain used to support the boom.
14. Connect the hydraulic hoses from the attachment to the skid steer if they are not already connected. Start the machine and lift the attachment bracket off the blocks.
15. Slowly work the backhoe functions in all directions, carefully monitoring for hydraulic hose positioning. If necessary, reposition any hoses that might get pinched during operation.
16. Lower the attachment. Shut off the skid steer's engine and check the hydraulic fluid level in the skid steer hydraulic reservoir. Add oil, if necessary. (Consult your skid steer manual regarding the type of oil recommended).

## Hardware Torque

	Grade 2 lb-ft 	Grade 5 lb-ft 	Grade 8 lb-ft 
¼"	66*	8	12
5/16"	10	17	20
3/8"	20	30	45
½"	45	75	110

\* = inch pounds

## Specifications

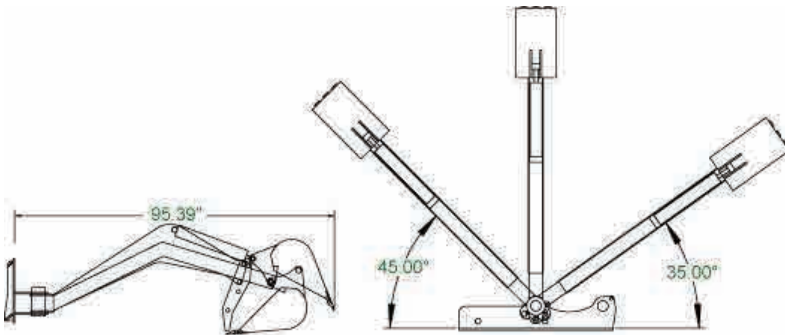

Spec.	Measurement
Attachment Length	95" (2413mm)
Dig Depth	7' (2.13m)
Attachment Weight less Bucket	600 lbs. (272 kg)
Bucket Weights:	
8" (203mm)	65 lbs. (30 kg)
12" (305mm)	100 lbs. (45 kg)
16" (406mm)	125 lbs. (57 kg)
20" (508mm)	150 lbs. (68 kg)
24" (610mm)	175 lbs (79 kg)

## Parts

When requiring any parts for your implement, please collect the following information:

- Implement Model Number
- Implement Serial Number
- Parts Manual Date (lower right corner)
- Parts Manual Page
- Part Description
- Quantity Required
- Ship-to Name & Address
- Payment Method

...then call your local dealer for factory fresh parts specifically designed for your attachment.

## Decals

1\*



2\*



3



Ref.	Description	Qty.
1*	Decal, (Danger Pinch Points)	2
2*	Decal, (Warning, High Pressure Fluid Hazard)	1
3	Identification Plate (Metal Plate)	1

\*



**WARNING**

*Replace any worn, torn or missing safety decals before operating!*

## Backhoe Parts

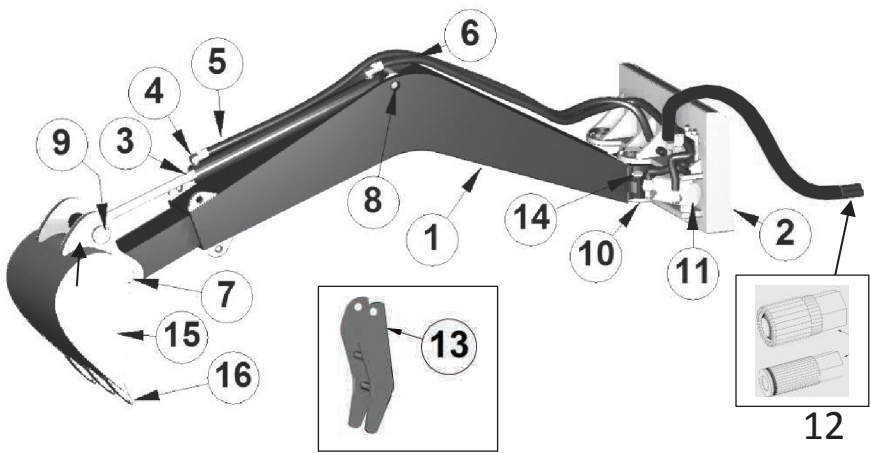

Ref.	Description	Qty.
1	Main Boom	1
2	Coupler Frame	1
3	Bucket Cylinder	1
4	Fitting, 90°	2
5	Hose, (Rod end of cylinder to Valve)	1
6	Hose, (Base end of cylinder to valve)	1
7	Pin, Bucket Pivot	1
8	Pin, (Base of bucket cylinder)	1
9	Pin, (Rod end of cylinder to bucket)	1
10	Pin, Swing	1
11	Cylinder, Swing	1
12	Quick Disconnect Coupling Set	1
13	Thumb (Optional) Kit	1
14	Pin, (Rod end of swing cylinder)	1
15	Bucket 8" (203mm)	A/R
	Bucket 12" (305mm)	
	Bucket 16" (406mm)	
	Bucket 20" (508mm)	
	Bucket 24" (610mm)	
16	Teeth, Bucket	A/R

## Hydraulic Parts

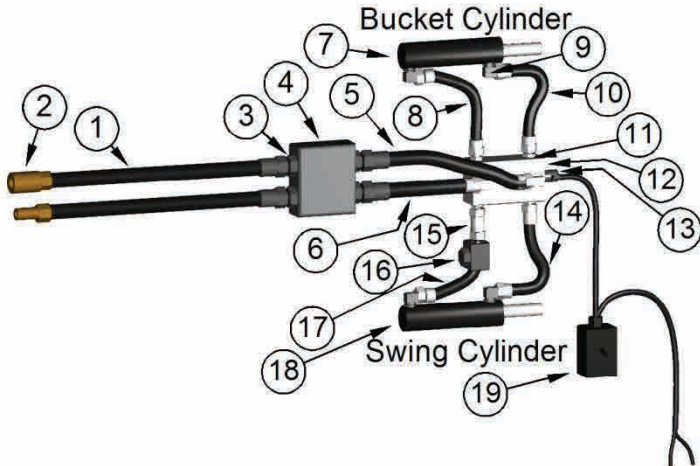

Ref.	Description	Qty.
1	Hose Kit (Skid Steer to cushion valve) 60"	1
2	Coupling, Quick Disconnect Set	1
3	Fitting	4
4	Valve, Cushion	1
5	Hose, 16"	1
6	Hose, 15"	1
7	Cylinder, Bucket	1
8	Hose, 92"	1
9	Fitting, 90°	6
10	Hose, 72"	1
11	Fitting	4
12	Valve, Selector Control	1
13	Valve, Solenoid	1
14	Hose, 35"	1
15	Hose, 3.5"	1
16	Valve, Flow	1
17	Hose, 37"	1
18	Cylinder, Swing	1
19	Switch Assy., Swing Selection	1
NS	Sleeve, Protective Hose Cover	A/R

Note: Stated hose lengths do not include fittings on ends.

## Troubleshooting

Problem	Cause	Resolution
Hydraulic oil level goes down during operation	Leak at valve or other plumbing	Investigate & repair
	Leaks in skid steer hydraulic system	Investigate & repair
Boom swing function does not operate	Electrical Problem	Check that electrical harness is connected to a 12V source and check that circuit is properly grounded.
		Search harness routing and check connections. Pinch marks in the harness may indicate that harness has incurred damage and may need to be repaired or replaced.
		With the engine turned off, but the ignition key in the “on” position, activate the swing switch and listen for a ‘click’ in the solenoid valve on the attachment. If no ‘click’ is heard, either there is no power getting to the solenoid or the solenoid coil has failed. Check for 12V at the coil harness connector with a multi-meter.
	Hydraulic Problem	Solenoid spool is jammed by a contaminant. Remove, clean or replace.
Check that swing flow valve (item #16 on page 14) has not been turned down too low. Adjust, if necessary		

***Think “Safety”  
Every Day!***



**107 E Holly Hill Rd.  
Thomasville, NC 27360**

# *Owner's Manual* **Swing Boom Backhoe**

*Website*

[www.carolinaattachments.com](http://www.carolinaattachments.com)

*For More Information, Contact*

[Wesley@Carolinaattachments.com](mailto:Wesley@Carolinaattachments.com)

Toll Free 888-676-7309

Local 336-474-7309

## **Limited Warranty**

Carolina Attachments, LLC, a manufacturer of quality skid steer attachments offers a 1 year limited warranty on all of our attachments. Excluding economy series attachments.

Carolina Attachments, LLC liability for any defect with respect to accepted goods shall be limited to repairing the goods at Carolina Attachments, LLC location or replacing them as Carolina Attachments, LLC shall elect. The above shall be in accordance with Carolina Attachments, LLC adjustment policies. Carolina Attachments, LLC obligation shall terminate twelve (12) months after the delivery of the attachment to original purchaser. This warranty shall not apply to any machine or attachment which shall have been repaired or altered outside Carolina Attachments, LLC. It will be Carolina Attachments, LLC judgment, to affect its stability or reliability, nor which has been misuse, negligence or accident beyond the manufacturer recommended machine rated capacity. If you have any questions in regards to this limited warranty please contact Carolina Attachments, LLC.

### **Warranty Claim**

To submit a warranty claim, authorization from Carolina Attachments, LLC must be obtained. This warranty does not include freight or delivery charges incurred when returning attachment for servicing. Pickup/delivery charges are the customer's responsibility.

### **Exclusions of Warranty**

Except as otherwise expressly stated herein, Carolina Attachments, LLC makes no representation or warranty of any kind, expressed or implied, AND MAKES NO WARRANTY OF MERCHANTABILITY IN RESPECT TO IF ATTACHMENTS ARE FIT FOR ANY PARTICULAR PURPOSE. Carolina Attachments, LLC is not liable for any inconvenience, rental or replacement equipment, loss of profits or other commercial loss. Buyer assumes all liability for all personal injury and property resulted from the handling, possession or use of the attachment by the buyer.